

BF-830X

User's Manual V2.0

2008.06.14

Table of Contents

- 1 About BF-830X
- 2 Features
 - 2.1 Characteristics
 - 2.2 Support Functions
- 3 Operation window
- 4 User's Menu
 - 4.1 For Card+Password verify user
 - 4.2 For Card verify user
- 5 Administrator Menu
 - 5.1 User
 - 5.1.1 Add User
 - 5.1.1.1 Single : Register a new user
 - 5.1.1.2 Continuous : Register new user continuously
 - 5.1.2 Delete User : Delete a registered user
 - 5.1.3 Activate User : To enable authority of user for using BF-830X
 - 5.1.4 Deactivate User : To disable authority of user for using BF-830X
 - 5.2 Settings
 - 5.2.1 Date & Time : Set Time 、 Date and Week
 - 5.2.2 Administrator
 - 5.2.2.1 Login P/W : Change manager's password
 - 5.2.2.2 Set Manager
 - 5.2.2.2.1 Add Manager : Create one user to be manager
 - 5.2.2.2.2 Del Manager : Delete one manager
 - 5.2.3 IP Config : Set IP Data of BF-830X
 - 5.3 Reset
 - 5.3.1 Reset Users : Delete all registered users
 - 5.3.2 Reset Logs : Delete all logs
 - 5.3.3 IP Config : Reset IP to factory default
 - 5.3.4 Reset Group : Delete all group 、 time zone and holiday setting
 - 5.4 Misc.
 - 5.4.1 User&Log : Display total number of registered users and total number of logs
 - 5.4.2 BF20/485 Reader : Show the status of BF-20 and reader
 - 5.4.3 SET TM Card
 - 5.4.3.1 Init TM Card : Initial TM card to EM format
 - 5.4.3.2 Write TM Card : Write ID number to TM card
- 6 Specifications
- 7 Appendix
 - 7.1 Notes
 - 7.2 External connector specifications

1 About BF-830X

BF-830X is developed to manage entrance security, work place time and attendance, over-work time verification and other situation requiring the presence of the authorized personnel.

BF-830X within 1 Card Reader, 128 X 64 pixel LCD screen, 10 push buttons, 6 function keys, 1 door bell button and 1 buzzer. These equipments make BF-830X user-friendly.

Through the build-in web , you can manage the branch office easily. Beside that, the user can check the in/out log by using IE.

2 Features

2.1 Characteristics

- **Entrance security, time and attendance, over-time management and other applications**
BF-830X system allows for entrance security, work place time and attendance, over-time work. Also, situations that require the presence of the authorized persons at a secured point can take advantage of our BF-830X system.
- **Special function keys may be configured to time and attendance and entrance access management**
4 programmable function keys can be used to manage time and attendance. One BF-830X can be adapted to manage many different kinds of work involving site security control and time and attendance.
- **Use of stand-alone modules or working as reader of BF-660X/670X/870X**
BF-830X entrance control system may be used as stand-alone units to control entrance traffic. Also, direct connection to a PC is possible via RS-232/RS-485 or TCP/IP protocol or working as reader of BF-660X/670X/870X by communication with BF-660X/670X/870X via TCP/IP. Because BF-830X content RTC and log management capabilities (up to 32,768 records), entrance security and other event management are possible without an ACU.
- **Convenient**
With build-in http server administrator can download data 、 modify setting 、 manager users and maintain system via Internet Explorer.

2.2 Support functions

2.2.1 User management

- Register a user, provides 2 type of register (1.Password 2.Card)
- Provide 32 designations and 32 departments
- User can set the employee limit period separately by truly situation
- User can set the attendance and time by the group
- Activate or deactivate user's authority
- View all registered ID list
- Delete a user or all users

2.2.2 System management

- You can use http server inside to revise the data and manage employee on Internet Explorer
- The system sets 2 level accounts and passwords to prevent the setting from change purposely
- You can set the terminal number, title, description, maintenance time, card ID display format and working stand alone or as reader of BF-660X/670X/870X
- Set the communicate status on line. For example, IP ADDRESS, Gateway, DNS, Port Number, Host Name.
- Set the clock on line. You can revise it by your hand or connect to the time server to revise everyday
- Provide 40 function key define and can used for in/out trigger setup
- Upgrade firmware on line
- You can backup or restore the user data directly
- You can import all user data directly on line

2.2.3 Door mode

- Provide 64 time set, 64 time zone, 32 group, 50 holiday
- You can connect door lock controller to set lock release time zone \ exit button work time zone and enable anti-pass back function(BF-20 and wiegand reader are required)
- Monitor entrance status on line
- You can turn on or close door security by real situation

2.2.4 Log

- Access log: each user or employee can check in or out log by through any computer
- Query log by user number, terminal number, department, function key or time period
- Query user first in and last out log in one day
- Export the in/out log (TXT and XLS format)
- Download the log by using the software

2.2.5 Authentication

- Authentication at the terminal by Card/Card+Password
- Collocate with group, time zone to set card+password identification time zone

2.2.6 Real time event

- Display user I.D. Name on LCD at authentication time.

2.2.7 Auxiliary function

- Exit button
- Relay out for lock driver

3 Operation window

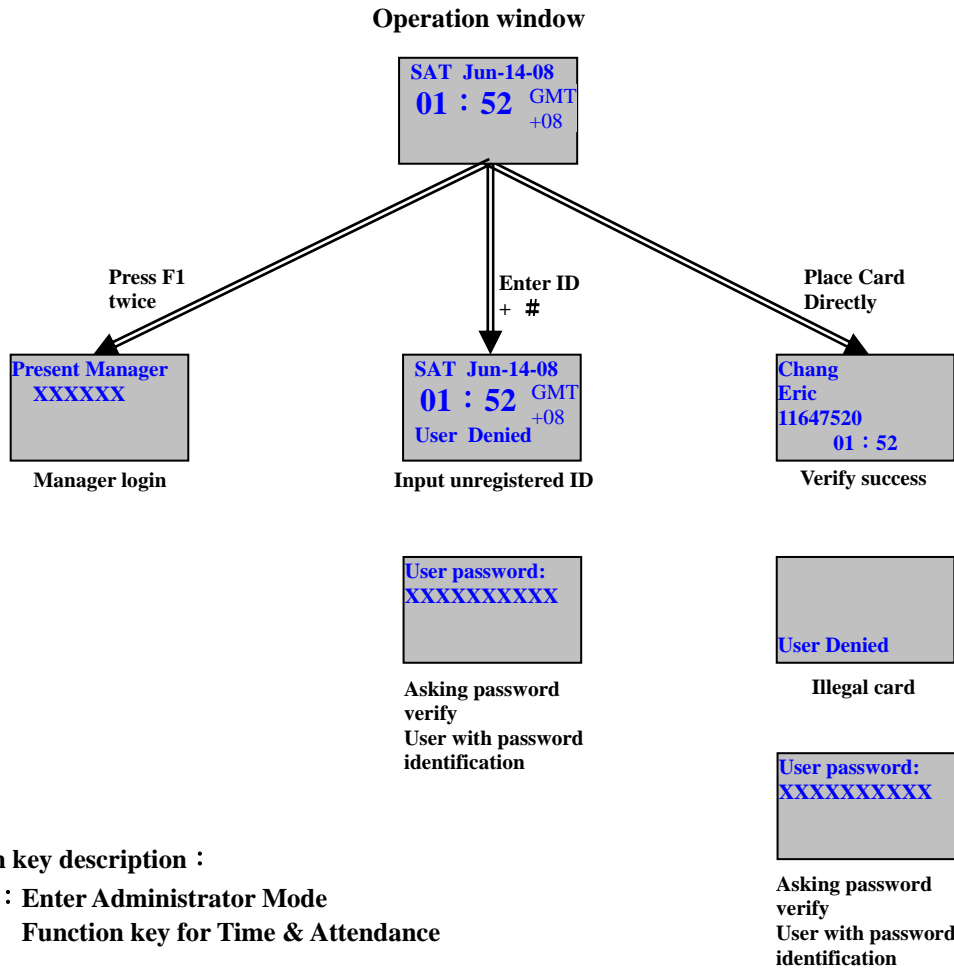

☞ **Function key description :**

- F1** : Enter Administrator Mode
Function key for Time & Attendance
- F2** : Function key for Time & Attendance
- F3** : Delete (Backspace)
Function key for Time & Attendance
- F4** : Function key for Time & Attendance
- #** : Confirm
- *** : Cancel
- 0** ~ **9** : Number key

4 User's Menu

4.1 For Card + Password verify user

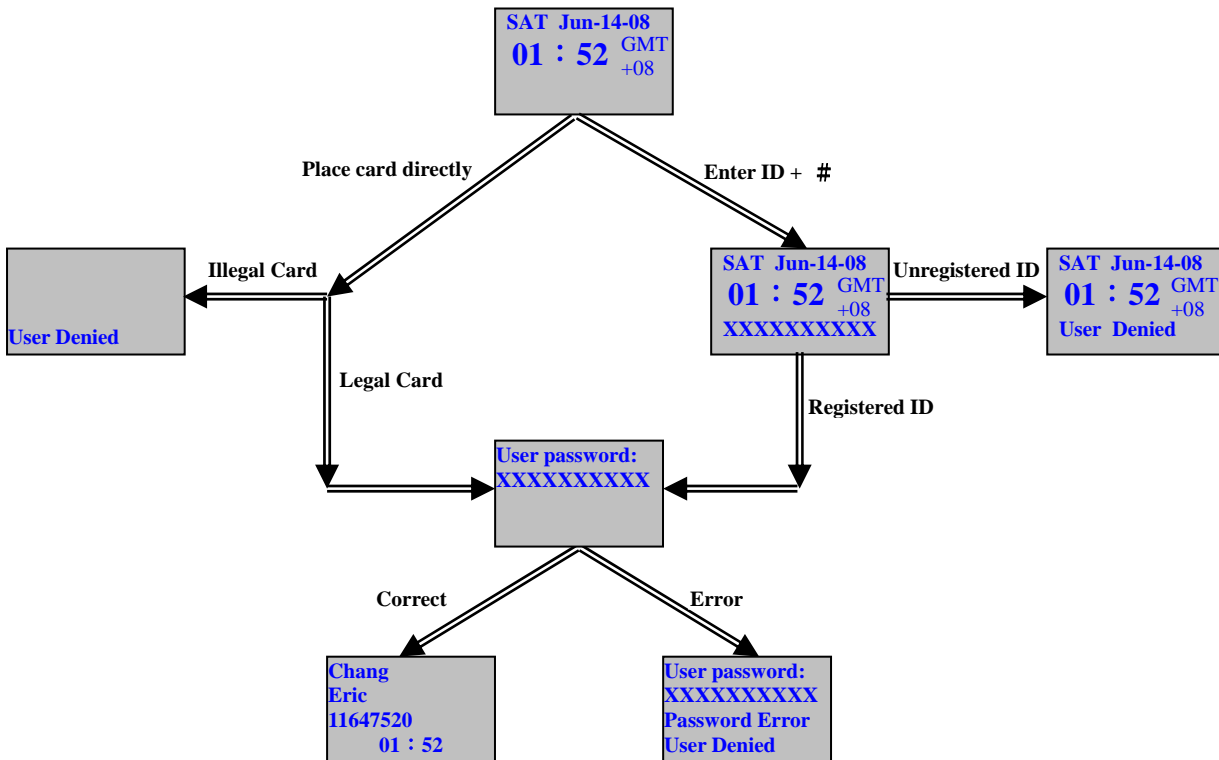

☞ Operation description :

Max. 950 users

Method 1 :

~ Enter ID

Press #

~ Enter password
6~10 digit

Press #

Method 2 :

Place sensor card on the coil directly

~ Enter password
6~10 digit

Press #

☞ Function key description :

: Enter Administrator Mode
Function key for Time & Attendance

: Function key for Time & Attendance

: Delete (Backspace)
Function key for Time & Attendance

: Function key for Time & Attendance

: Confirm

: Cancel

~ : Number key

Note : 1. If you use function key please press function key first

2. If you want to show name on LCD then you must enter name in BF-830's web setting

4.2 For card verify user

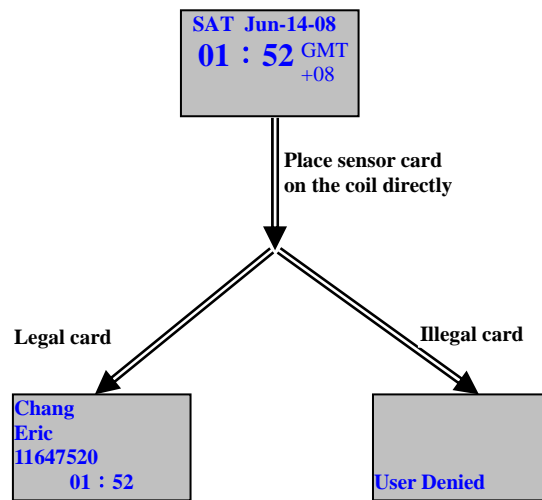

☞ Operation description :

Max. 950 users

Place sensor card on the coil directly

Note : 1. If you use function key please press function key first

2. If you want to show name on LCD then you must enter name in BF-830's web setting

☞ Function key description :

F1 : Enter Administrator Mode
Function key for Time & Attendance

F2 : Function key for Time & Attendance

F3 : Delete (Backspace)
Function key for Time & Attendance

F4 : Function key for Time & Attendance

: Confirm

***** : Cancel

0 ~ **9** : Number key

5 Administrator Menu

Administrator menu allows new user registration and deletion, and system configuration. Press “F1” twice to enter. Default password is “111111” .

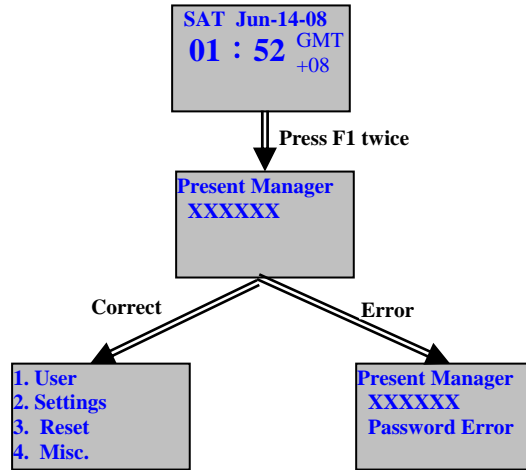

☞ Operation description :

- F1** Press F1 twice
- 0** ~ **9** Enter 6 digit password
default value is 111111
- #** Press #
- 0** ~ **9** Press 1~4 to select
- *** Press * to exit

☞ Function key description :

- F1** : Enter Administrator Mode/Page Up
- F2** : Page Down
- F3** : Delete (Backspace)
- F4** : No use
- #** : Confirm
- *** : Cancel
- 0** ~ **9** : Number key

5.1 User

5.1.1 Add User : register a new user

5.1.1.1 Single

5.1.1.1.1 Card + Password verify user

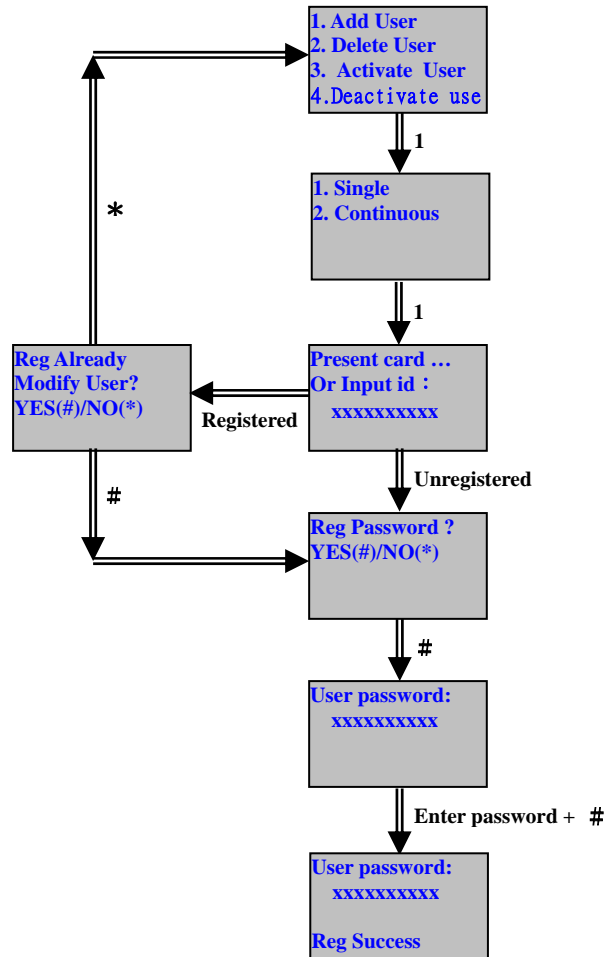

☞ Operation description :

- ~ Press 1
- ~ Press 1
- ~ Enter ID or Place sensor card on the coil
- Press #
- Press # to register password
- ~ Enter password 6~10 digit
- Press #

☞ Function key description :

- : Enter Administrator Mode/Page Up
- : Page Down
- : Delete (Backspace)
- : No use
- : Confirm
- : Cancel
- ~ : Number key

5.1.1.1.2 Card verify user

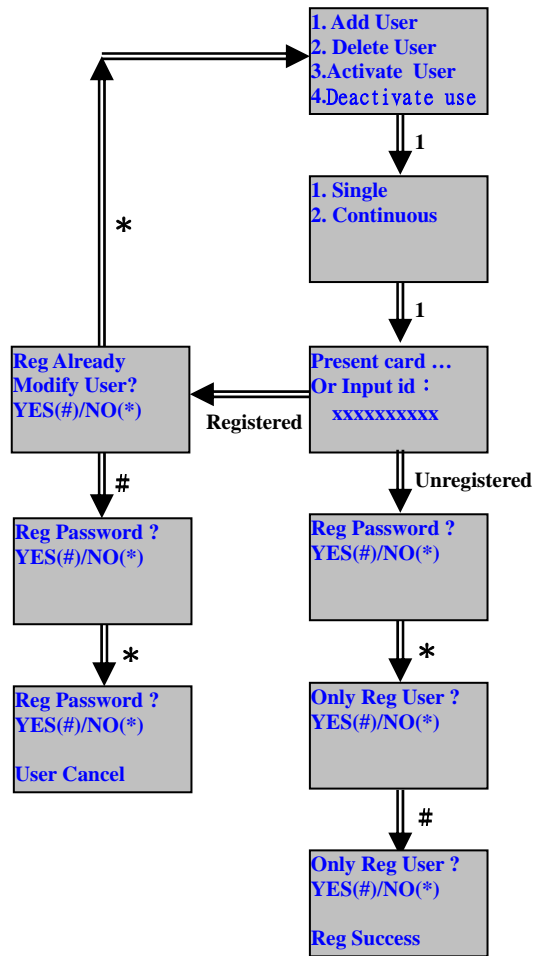

☞ Operation description :

0 ~ **9** Press 1

0 ~ **9** Press 1

Place sensor card on the coil

***** Press ***** to cancel password register

Press **#** to confirm

☞ Function key description :

F1 : Enter Administrator Mode/Page Up

F2 : Page Down

F3 : Delete (Backspace)

F4 : No use

: Confirm

***** : Cancel

0 ~ **9** : Number key

5.1.1.2 Continuous

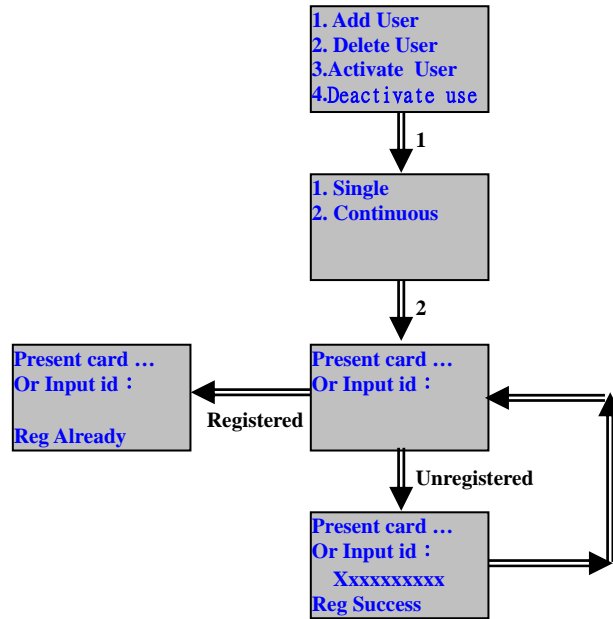

☞ Operation description :

~ Press 1

~ Press 2

Place sensor card on the coil

☞ Function key description :

: Enter Administrator Mode/Page Up

: Page Down

: Delete (Backspace)

: No use

: Confirm

: Cancel

~ : Number key

5.1.2 Delete User : Del one registered user

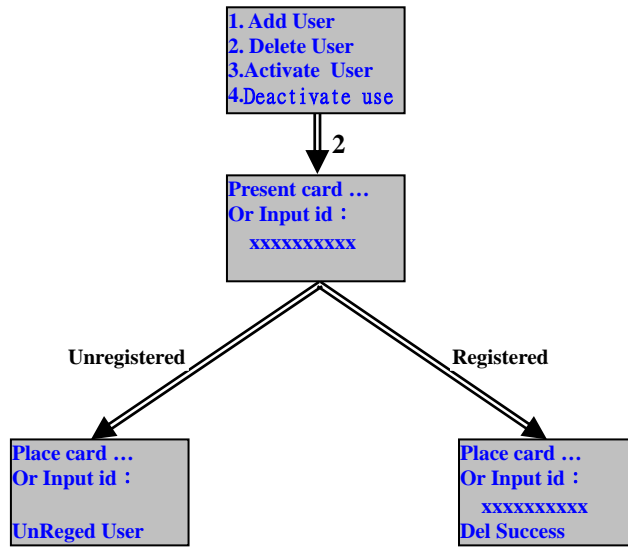

☞ Operation description :

- ~ Press 2
- ~ Enter ID or Place sensor card on the coil
- Press #

☞ Function key description :

- : Enter Administrator Mode/Page Up
- : Page Down
- : Delete (Backspace)
- : No use
- : Confirm
- : Cancel
- ~ : Number key

5.1.3 Activate User : To enable authority of user for using BF-830X

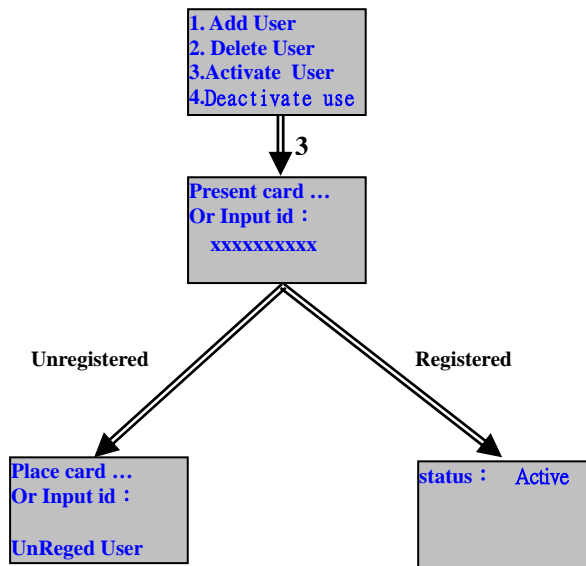

☞ Operation description :

- ~ Press 3
- ~ Enter ID or Place sensor card on the coil
- Press #

☞ Function key description :

- : Enter Administrator Mode/Page Up
- : Page Down
- : Delete (Backspace)
- : No use
- : Confirm
- : Cancel
- ~ : Number key

5.1.4 Deactivate Use : To disenable authority of user for using BF-830X

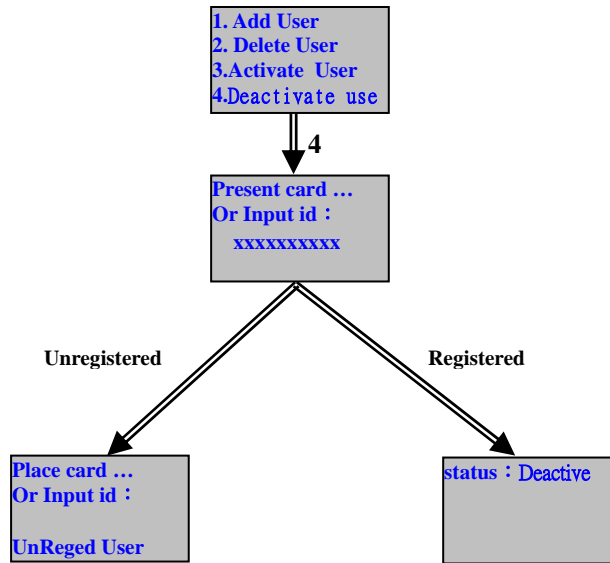

☞ Operation description :

- 0** ~ **9** Press 4
- 0** ~ **9** Enter ID or Place sensor card on the coil
- #** Press #

☞ Function key description :

- F1** : Enter Administrator Mode/Page Up
- F2** : Page Down
- F3** : Delete (Backspace)
- F4** : No use
- #** : Confirm
- *** : Cancel
- 0** ~ **9** : Number key

5.2 Settings

5.2.1 Date & Time: Set time, date and week of BF-830X

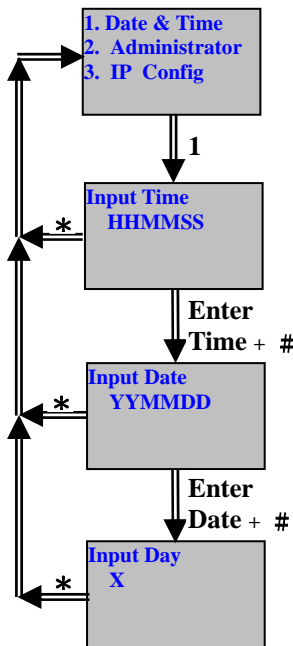

Operation description :

- ~ Press 1
- ~ Enter time HHMMSS
- Press #
- ~ Enter date YYYYMMDD
- Press #
- ~ Enter week 1~7 Means MON~SUN
- Press #

Function key description :

- : Enter Administrator Mode Page Up
- : Page Down
- : Delete (Backspace)
- : No use
- : Confirm
- : Cancel
- ~ : Number key

5.2.2 Administrator

5.2.2.1 Login P/W : Change manager's password

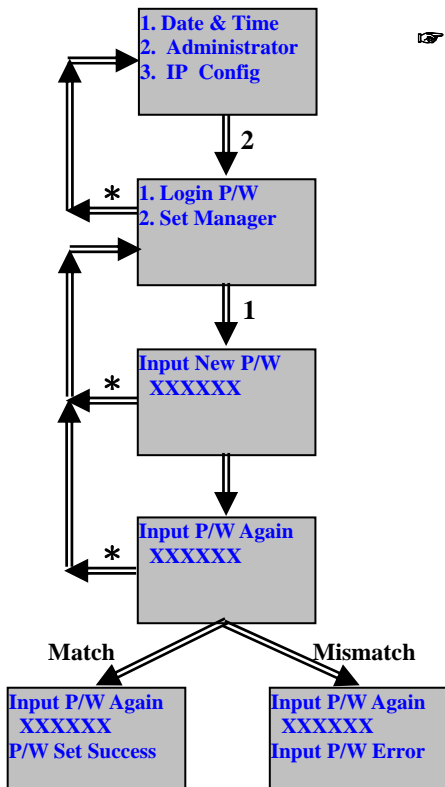

Operation description :

- ~ Press 2
- ~ Enter 6 digits password
- Press #
- ~ Enter 6 digits password
- Press #

Function key description :

- : Enter Administrator Mode Page Up
- : Page Down
- : Delete(Backspace)
- : No use
- : Confirm
- : Cancel
- ~ : Number key

5.2.2.2 Set Manager

5.2.2.2.1 Add Manager : Create one Manager (Max 5)

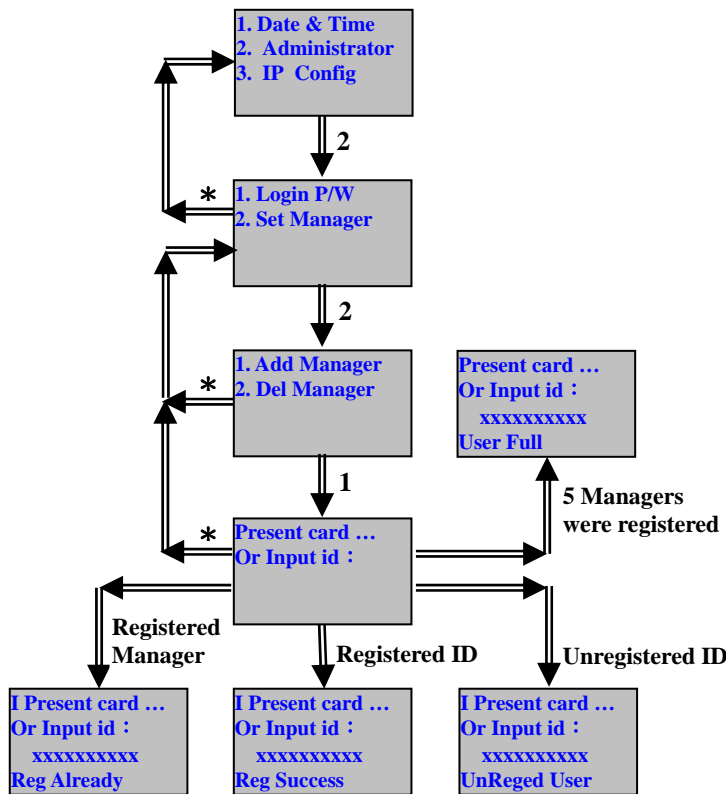

Operation description :

- ~ Press 2
- ~ Press 2
- ~ Press 1
- ~ Enter ID or place card
- Press # if enter ID by keypad

Note : Password for login management will be disabled after assigning manager

Function key description :

- : Enter Administrator Mode
Page Up
- : Page Down
- : Delete(Backspace)
- : No use
- : Confirm
- : Cancel
- ~ : Number key

5.2.2.2.2 Del Manager : Delete one Manager

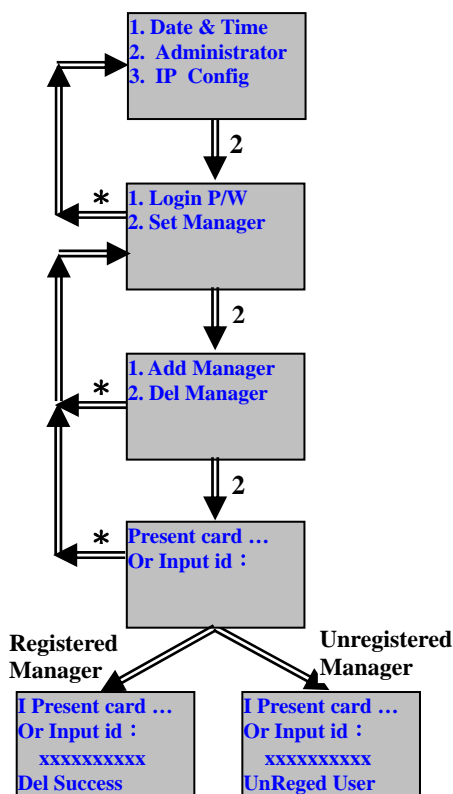

Operation description :

- ~ Press 2
- ~ Press 2
- ~ Press 2
- ~ Enter ID or place card
- Press # if enter ID by keypad

Note : If all managers are deleted then user must use login password to enter management Menu

Function key description :

- : Enter Administrator Mode
Page Up
- : Page Down
- : Delete(Backspace)
- : No use
- : Confirm
- : Cancel
- ~ : Number key

5.2.3 IP Config: Set IP data of BF-830X

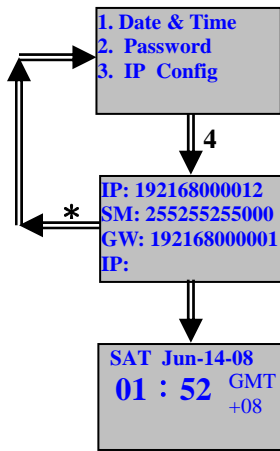

Operation description :

- ~ Press 3
- ~ Enter IP 、 Subnet mask 、 Gateway
- Press #

Note :

The format of IP 、 subnet mask and gateway are as follow
 If you want to set IP as 192.168.0.12 then enter 192168000012
 If you want to set subnet mask as 255.255.255.0 then enter 255255255000
 If you want to set gateway as 192.168.0.1 then enter 192168000001

Function key description :

- : Enter Administrator Mode Page Up
- : Page Down
- : Delete(Backspace)
- : No use
- : Confirm
- : Cancel
- ~ : Number key

5.3 Reset

5.3.1 Reset Users : Delete all registered users

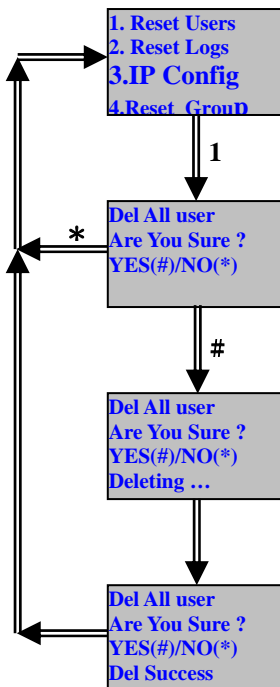

Operation description :

- ~ Press 1
- Press #

Function key description :

- : Enter Administrator Mode Page Up
- : Page Down
- : Delete (Backspace)
- : No use
- : Confirm
- : Cancel
- ~ : Number key

5.3.2 Reset Logs : Delete all logs

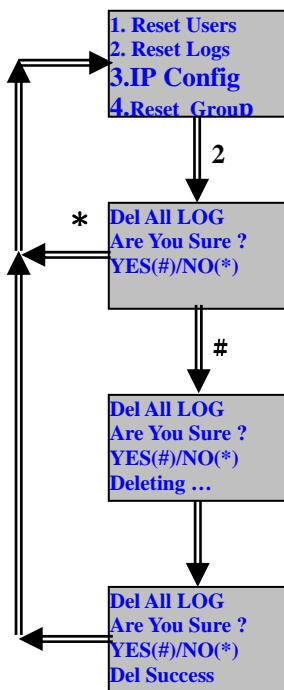

☞ Operation description :

0 ~ **9** Press 2
Press

☞ Function key description :

F1 : Enter Administrator Mode
Page Up
F2 : Page Down
F3 : Delete (Backspace)
F4 : No use
: Confirm
***** : Cancel
0 ~ **9** : Number key

5.3.3 IP Config : Reset IP to factory default

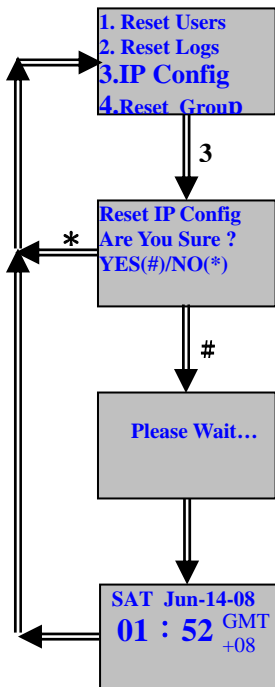

☞ Operation description :

0 ~ **9** Press 3
Press

☞ Function key description :

F1 : Enter Administrator Mode
Page Up
F2 : Page Down
F3 : Delete (Backspace)
F4 : No use
: Confirm
***** : Cancel
0 ~ **9** : Number key

5.3.4 Reset Group : Delete Group、Time Zone and Holiday setting

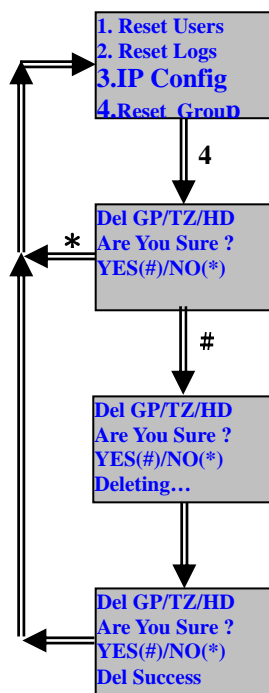

☞ Operation description :

~ Press 4
 Press #

☞ Function key description :

: Enter Administrator Mode
Page Up
 : Page Down
 : Delete (Backspace)
 : No use
 : Confirm
 : Cancel
 ~ : Number key

5.4 Misc.

5.4.1 User&Log : Display total number of registered users and total number of logs

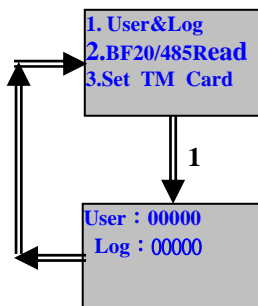

☞ Operation description :

~ Press 1

☞ Function key description :

: Enter Administrator Mode
Page Up
 : Page Down
 : Delete (Backspace)
 : No use
 : Confirm
 : Cancel
 ~ : Number key

5.4.2 BF20/485 Reader : Display BF-20 and Reader that connected to BF-830X

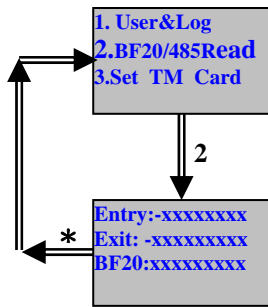

☞ Operation description :

~ Press 2

☞ Function key description :

: Enter Administrator Mode
Page Up

: Page Down

: Delete (Backspace)

: No use

: Confirm

: Cancel

~ : Number key

5.4.3 Set TM Card

5.4.3.1 Init TM Card : Initial TM card to EM format

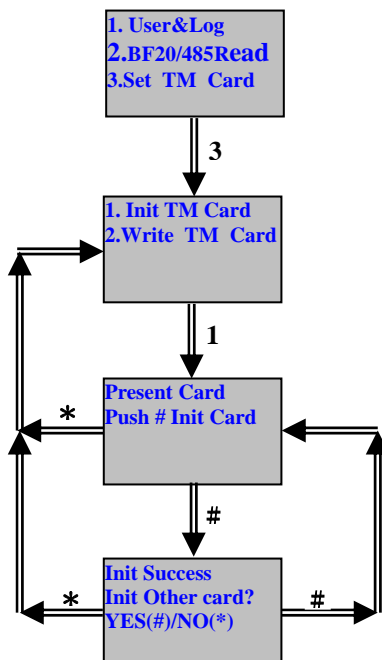

☞ Operation description :

~ Press 3

~ Press 1

Press #

Place sensor card on the coil

☞ Function key description :

: Enter Administrator Mode
Page Up

: Page Down

: Delete (Backspace)

: No use

: Confirm

: Cancel

~ : Number key

5.4.3.2 Write TM Card : Write ID number to TM card

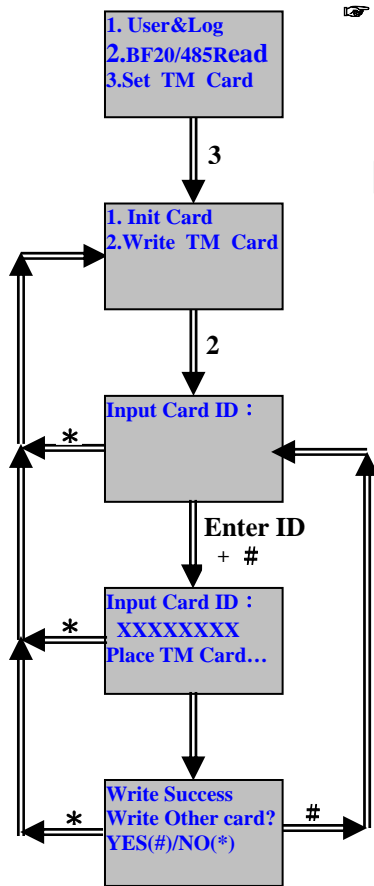

☞ Operation description :

- ~ Press 3
- ~ Press 2
- ~ Enter ID+ #
ID must less than 4294967295

Place sensor card on the coil

☞ Function key description :

- : Enter Administrator Mode
Page Up
- : Page Down
- : Delete (Backspace)
- : No use
- : Confirm
- : Cancel
- ~ : Number key

6 Specifications

6.1 Module Features

- CPU board
- LCD and Keypad board

6.2 Power Supply

6.2.1 Voltage

- +9V to +30V DC

6.2.2 Current

- Average: 600mA, 12V
- Maximum power consumption: 800mA, 12V

6.3 Environment

6.3.1 Temperature and humidity

- Operating temperature: 0°C to 55°C
- Storage temperature: -20°C to 70°C
- Operating humidity: 0% to 90%
- Storage humidity: 0% to 905%

6.3.2 Immunity to electro static discharge

- Serial port 15kv ESD °
- Ethernet port 1.5kv °

6.4 Communication

- 1 RJ-45 port(10/100M) for management
- 1 wiegand output
- 1 RS-485 port meet RS485 specifications

6.5 Drivers

- Door Relay * 1
- Door bell * 1
- Exit button contact * 1
- Emergency contact * 1 (For fire alarm)
- Case open alarm * 1

6.6 Capacity

- 950 persons with 1 card/1 password per person.

6.7 Log entry memory

- 32768 log entries total.

6.8 Size(yet to be set)

- CPU board: 109 mm (H) X 82 mm(W)
- LCD and Keypad board: 106 mm (H) X 82 mm (W)
- BF-830X: 125 mm(H) X 145 mm(W) X 33 mm(D)

6.9 Weight

- 300g

6.10 Authentication time

- Average : shorter than 1 second.

6.11 Input

- 10 number keys + 6 function keys + 1 door bell key

6.12 Display

- 1 Buzzer
- 1 LCD: 128 X 64 pixels
- 4 LED

7 Appendix

7.1 External connector specifications

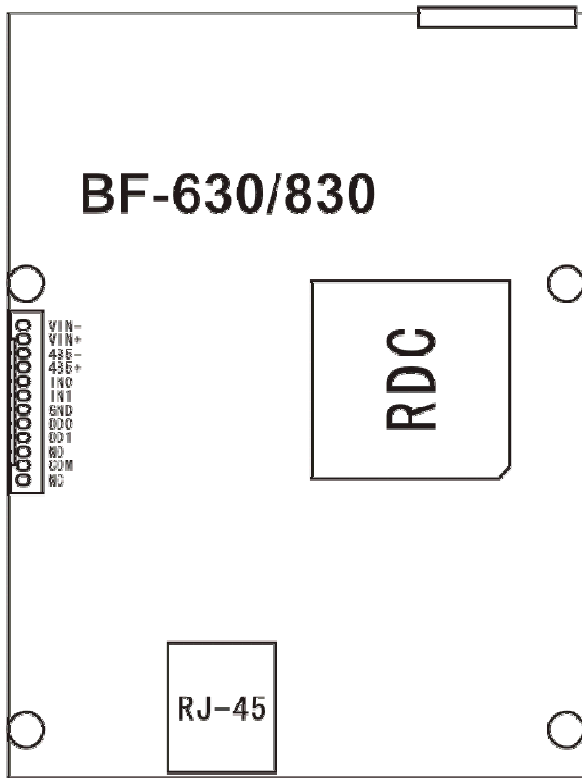

BF-830X

Power contact	VIN-	DC 12V negative pole
	VIN+	DC 12V positive pole
RS485 contact	485-	For BF-20 and using BF-20's wiegand in to connect wiegand reader to substitute exit button for recording exit log
	485+	
Exit button	IN0	Short with VIN+ to active door relay
Emergency button	IN1	Short with VIN+ to active door relay and keep on opening until reboot
GND	GND	
Wiegand output	OD0	Output Card ID for other equipment
	OD1	
Door Relay	NO	Door relay NO contact
	COM	Door relay COM contact
	NC	Door relay NC contact

Open when power on	<ol style="list-style-type: none"> 1. Positive pole of power supply connects to positive pole of EM lock. 2. Negative pole of power supply connects to COM of door relay. 3. NO of door relay connects to negative pole of EM lock.
Open when power off	<ol style="list-style-type: none"> 1. Positive pole of power supply connects to positive pole of EM lock. 2. Negative pole of power supply connects to COM of door relay. 3. NC of door relay connects to negative pole of EM lock.1.